

GOODWE



User Manual

Rechargeable Li-ion Battery System

Lynx Home D Series

V1.4-2025-04-27

Copyright © GoodWe Technologies Co.,Ltd. 2025. All rights reserved.

No part of this manual can be reproduced or transmitted to the public platform in any form or by any means without the prior written authorization of GoodWe Technologies Co.,Ltd.

Trademarks

GOODWE and other GoodWe trademarks are trademarks of GoodWe Technologies Co.,Ltd. All other trademarks or registered trademarks mentioned in this manual are owned by the company.

NOTICE

The information in this user manual is subject to change due to product updates or other reasons. This guide cannot replace the product labels or the safety precautions in the user manual unless otherwise specified. All descriptions in the manual are for guidance only.

CONTENT

- 1 About This Manual 01**
 - 1.1 Applicable Model..... 01
 - 1.2 Target Audience 01
 - 1.3 Symbol Definition..... 01
- 2 Safety Precaution 02**
 - 2.1 General Safety 02
 - 2.2 Battery Safety 03
 - 2.3 Emergency Measures 05
 - 2.4 EU Declaration of Conformity..... 05
- 3 Product Introduction 06**
 - 3.1 Product Overview..... 06
 - 3.2 Application Scenarios 08
 - 3.3 Appearance..... 09
- 4 Check and Storage 12**
 - 4.1 Check Before Receiving..... 12
 - 4.2 Deliverables 12
 - 4.3 Storage 15
- 5 Installation 16**
 - 5.1 Installation Requirements..... 16
 - 5.2 Moving the Equipment..... 18
 - 5.3 Installing the Battery System 18
 - 5.3.1 Installing the Wall Mount Rack (Optional)..... 19
 - 5.3.2 Installing the Base (Optional)..... 20
 - 5.3.3 Installing the Battery System..... 20
- 6 Electrical Connection 22**
 - 6.1 Safety Precaution 22
 - 6.2 Electrical Connection 22
 - 6.3 Connecting the PE Cable 24
 - 6.4 Connecting the DC power cable..... 25
 - 6.5 Connecting the Communication Cable and Installing the Terminal Resistor
29
 - 6.6 Installing Protective Cover 30

- 7 System Operation 31**
 - 7.1 Check Before Power On 31
 - 7.2 Battery System Power On 31
 - 7.3 Setting Battery Parameters 33
 - 7.4 Indicator Status 35
- 8 Maintenance 36**
 - 8.1 Battery System Power Off 36
 - 8.2 Routine Maintenance 37
 - 8.3 Troubleshooting 37
 - 8.4 System Troubleshooting 38
- 9 Technical Parameters 41**

1 About This Manual

This manual describes the product information, installation, electrical connection, commissioning, troubleshooting, and maintenance. Read through this manual before installing and operating the product. All the installers and users have to be familiar with the product features, functions, and safety precautions. This manual is subject to update without notice. For more product details and latest documents, visit <https://en.goodwe.com>.

1.1 Applicable Model



This manual applies to products with models LX D5.0-10.

1.2 Target Audience

This manual applies to trained and knowledgeable technical professionals only. The technical personnel has to be familiar with the product, local standards, and electric systems.

1.3 Symbol Definition

Different levels of warning messages in this manual are defined as follows:

 DANGER
Indicates a high-level hazard that, if not avoided, will result in death or serious injury.
 WARNING
Indicates a medium-level hazard that, if not avoided, could result in death or serious injury.
 CAUTION
Indicates a low-level hazard that, if not avoided, could result in minor or moderate injury.
NOTICE
Highlights key information and supplements other text. It may include skills and methods to solve product-related problems.

2 Safety Precaution

Please strictly follow these safety instructions in the user manual during the operation.



WARNING

The battery system is designed and tested to strictly comply with related safety rules. Read and follow all the safety instructions and cautions before any operations. Improper operation might cause personal injury or property damage as the battery system is electrical equipment.

2.1 General Safety

NOTICE

- The information in this user manual is subject to change due to product updates or other reasons. This guide cannot replace the product labels or the safety precautions in the user manual unless otherwise specified. All descriptions in the manual are for guidance only.
- Before installations, read through the user manual to learn about the product and the precautions.
- All operations should be performed by trained and knowledgeable technicians who are familiar with local standards and safety regulations.
- Use insulating tools and wear personal protective equipment when operating the equipment to ensure personal safety. Wear anti-static gloves, clothes, and wrist strips when touching electronic devices to protect the inverter from damage.
- Strictly follow the installation, operation, and configuration instructions in this guide and user manual. The manufacturer shall not be liable for equipment damage personal injury if you do not follow the instructions. For more warranty details, please visit <https://en.goodwe.com/warranty>.

2.2 Battery Safety















DANGER

- High voltage exists during the battery system running. Power off the battery system before any operations to avoid danger. Strictly follow all safety precautions outlined in this manual and safety labels on the equipment during the operation.
- The inverter used with the battery shall be approved by the battery manufacturer. The approved inverter list can be obtained through the official website.
- Do not disassemble, modify, or replace any part of the battery without official authorization from the manufacturer. Otherwise, it may cause electrical shock or damages to the equipment for which the manufacturer shall not be held responsible.
- Do not hit, pull, drag, squeeze or step on the System or put the battery into fire. Otherwise, the battery may explode.
- Do not place the battery in a high temperature environment. Make sure that there is no direct sunlight and no heat source near the battery. When the ambient temperature exceeds 60 °C, it will cause fire.
- Do not use the battery module if it is defective, broken, or damaged. Damaged battery may leak electrolyte.
- To protect the battery pack and its components from damage during transportation, please ensure that the transportation personnel are professionally trained. All operations during the transportation have to be recorded. The equipment shall be kept in balance to avoid falling down.
- Consider the weight of the equipment before moving it. Assign enough personnel to move the equipment to avoid personnel injury.
- Contact after-sale service immediately if the battery is not able to be started. Otherwise, the battery might be damaged permanently.
- Do not move the battery when it is working. Contact after-sales service if the battery shall be replaced or added.

CAUTION

- Protect the battery system from damage during transportation and storage.
- The transportation must be carried out by trained professionals. All operations during the process have to be recorded.
- Keep the equipment stable to avoid dumping, which can result in equipment damage and personal injuries.
- Place the cables at least 30mm away from the heating components or heat sources, otherwise the insulation layer of the cables may be aging or broken due to high temperature.
- Tie the same type cables together, and place cables of different types at least 30mm apart. Do not place the cables entangled or crossed.

Label Description

	Potential risks exist. Wear proper personnel protective equipment before any operations.		Install the equipment away from open flames or fire sources.
	High voltage hazard. High voltage exists when the equipment is running. Disconnect all incoming power and turn off the equipment before working on it.		Keep the equipment away from children.
	Operate the equipment properly to avoid explosion.		Do not dispose of the equipment with household garbage at its end of life. Dispose it according to local laws and regulations or send it to the manufacturer.
	The equipment contains corrosive electrolytes. In case of a leak in the equipment, avoid contact the leaked liquid or gas.		Recycle regeneration mark.
	The battery contains flammable materials, beware of fire.		TUV Mark.
	Read through the user manual before any operations.		CE Mark.
	Pay attention to wear personal protective equipment during installation, operation and maintaining of the equipment.		RCM Mark.
	Grounding point.	-	-

2.3 Emergency Measures

Battery Electrolyte Leakage

If the battery module leaks electrolyte, avoid contact with the leaking liquid or gas. The electrolyte is corrosive. It will cause skin irritation or chemical burn to the operator. Anyone contact the leaked substance accidentally has to do as following:

- Breath in the leaked substance: Evacuate from the polluted area, and seek immediate medical assistance.
- Eye contact: Rinse your eyes for at least 15 minutes with clean water and seek immediate medical assistance.
- Skin contact: Thoroughly wash the touch area with soap and clean water, and seek immediate medical assistance.
- Ingestion: Induce vomiting, and seek immediate medical assistance.

Fire

- The battery may explode when the ambient temperature exceeds 150°C. Poisonous and hazard gas may be released if the battery is on fire.
- In the event of a fire, please make sure that the carbon dioxide extinguisher or Novec1230 or FM-200 is nearby.
- When a fire occurs, please do not approach and immediately call the fire alarm number, notify firefighters, and provide product information.
- The fire cannot be put out by water or ABC dry powder extinguisher. Firefighters are required to wear full protective clothing and self-contained breathing apparatus.

2.4 EU Declaration of Conformity

GoodWe Technologies Co., Ltd. hereby declares that the inverter without wireless communication modules sold in the European market meets the requirements of the following directives:

- Electromagnetic compatibility Directive 2014/30/EU (EMC)
- Electrical Apparatus Low Voltage Directive 2014/35/EU (LVD)
- Battery Directive 2006/66/EC and Amending Directive 2013/56/EU
- Waste Electrical and Electronic Equipment 2012/19/EU
- Registration, Evaluation, Authorization and Restriction of Chemicals (EC) No 1907/2006 (REACH)
- Battery Directive 2006/66/EC
- You can download the EU Declaration of Conformity on the official website: <https://en.goodwe.com/>

3 Product Introduction

3.1 Product Overview

Intended usage

The battery system can store and release electricity according to the requirements of the PV energy storage system, and the input and output ports of the energy storage system are all high-voltage direct current.

Model

This manual applies to the listed battery below:

- LX D5.0-10

Model Description

LX D5.0-10

1 2 3

No.	Referring to	Description
1	Series code	Lynx Home D series
2	Usable energy	5.0: the usable energy of the battery system is 5.0kWh.
3	Version code	10: version of the battery system is 1.0.

SN Code

*****2388*****

The 11th-14th digits

The 11th to 14th digits of the product SN code are the production time code.

- The first two numbers are the last two digits of the production year, such as 2023 represented by 23;
- The third number represents the production month, as follows:

Month	January~September	October	November	December
Month's Code	1~9	A	B	C

- The fourth number is the production date, which is represented by numbers first. For example, 1-9 represents the 1st to 9th day, A represents the 10th day, and so on. Letters I and O are not used to avoid confusion. For example:

Production Date	1st~9th Day	10th Day	...	18th Day	...
Code	1~9	A	...	J	...

Usable energy description

NOTICE

- The battery system supports capacity expansion. A maximum of 2 groups of batteries (up to 4 battery modules per group) and a total of 8 battery modules can be used to extend the usable energy of the battery system.
- Each battery has a usable energy of 5kWh, and the total capacity of n+m batteries is n+m multiply by 5kWh.

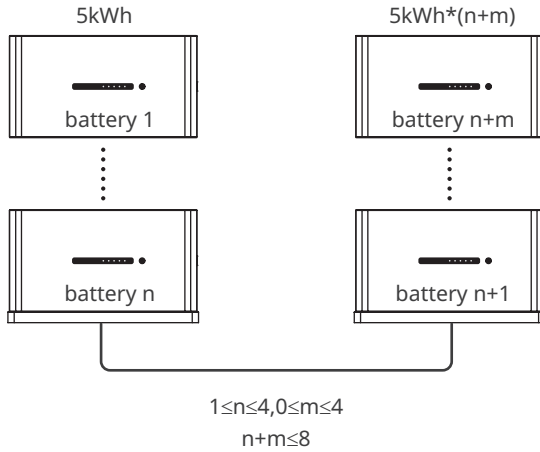

3.2 Application Scenarios

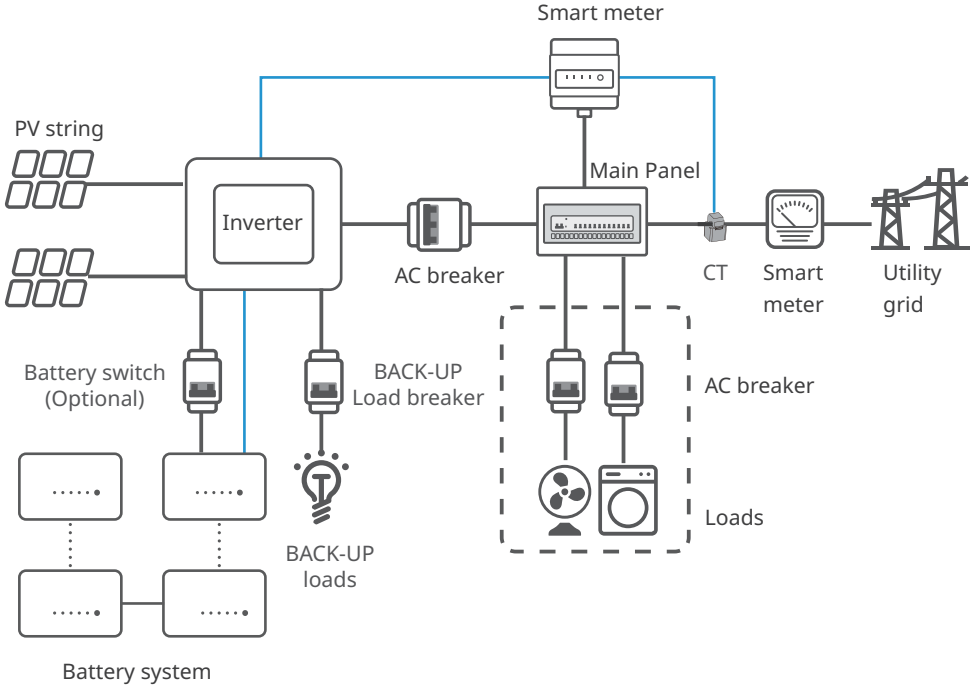

Approved inverter list

Scan the QR code below or visit the official website to get the Approved Battery Options Statement.



GoodWe Inverter



GE Inverter

3.3 Appearance

Parts

Front View

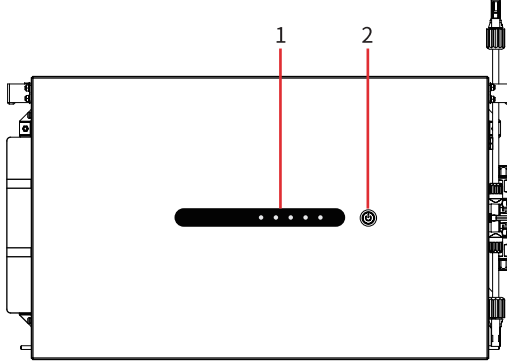

Left View

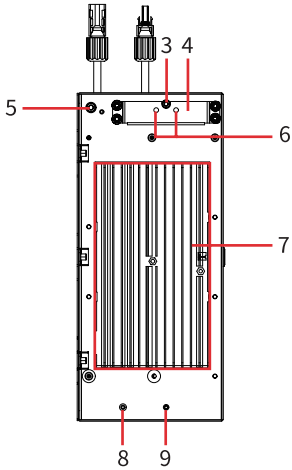

Right View

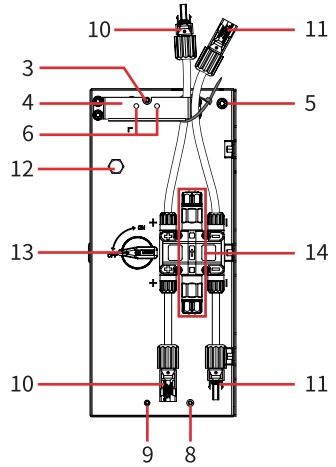

No.	Parts	Description
1	Battery SOC indicator light	<ul style="list-style-type: none"> • SOC indicator light: Displays the battery SOC status. • Multi-function button indicator <ul style="list-style-type: none"> • Black start function: When there is no PV generating electricity in the PV system and the power grid is abnormal, if the inverter cannot work properly, you can press and hold the multi-functional button for 2 seconds to start the battery system and inverter. The inverter will then enter off-grid mode and the loads can be powered by the battery • Long press the multi-function button for 5s to power off the battery system. • Combines the SOC indicator light and multi-function button indicator to check the battery system working status, alarm status and fault status.
2	Multi-function button indicator	
3	Fixing hole between batteries or grounding port	Used for fixing batteries or for connecting grounding wires.
4	Handle	Used for moving batteries.
5	Fixing hole between battery and wall	Used for fixing between battery and wall.
6	Protective cover fixing hole	Used for installing protective cover.
7	Cooling fin	Used for heat dissipation.
8	Protective cover fixing hole	Used for installing protective cover.
9	Fixing hole between batteries	Used for fixing batteries.
10	Battery positive electrode connection terminal	Used for connecting the battery or inverter positive pole.
11	Battery negative electrode connection terminal	Used for connecting the battery or inverter negative pole.
12	Breather valve	Used for balancing the internal and external pressure of the battery.
13	Battery power switch	Battery power input/output switch.
14	Communication connection port	Used for connecting the communication cables between battery and inverter, battery and battery or connecting terminal resistor.

Dimensions

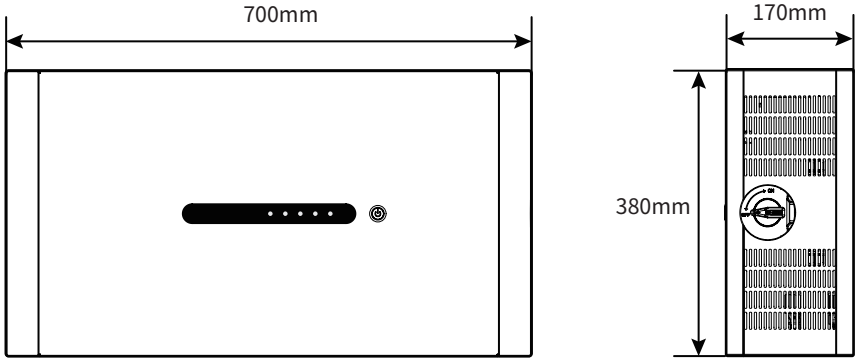

Battery group dimensions (ground installation)

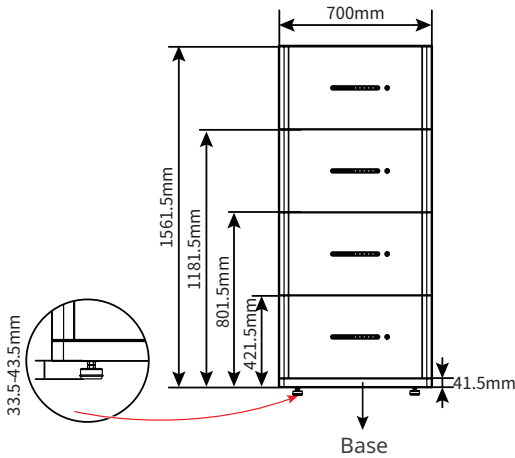

Battery group dimensions (wall-mount installation)

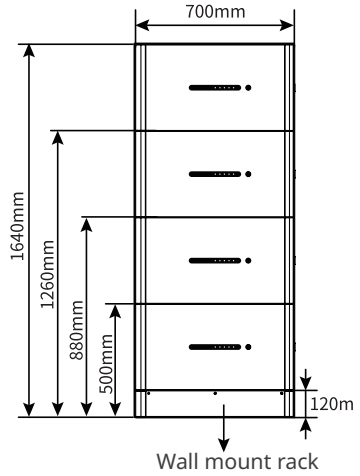

4 Check and Storage

4.1 Check Before Receiving

Check the following items before receiving the product.

1. Check the outer packing box for damage, such as holes, cracks, deformation, and other signs of equipment damage. Do not unpack the contents from the box and contact the supplier as soon as possible if any damage is found.
2. Check the battery model. If the model is not what you requested, do not unpack the product and contact the supplier.
3. Check the deliverables for correct model, complete contents, and intact appearance. Contact the supplier as soon as possible if any damage is found.

4.2 Deliverables

Battery

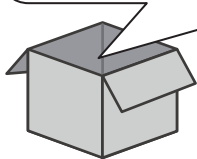
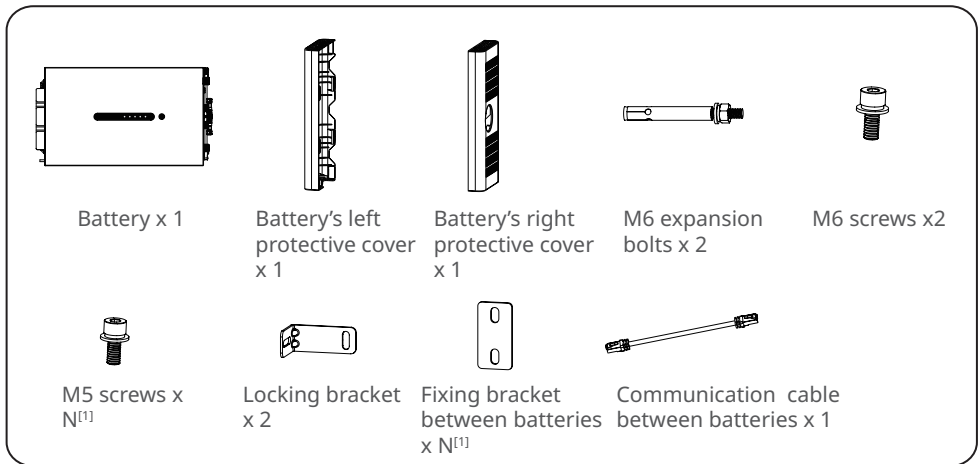











[1]:

- Fixing bracket between batteries delivered as accessories: Fixing bracket between batteries *2; M5 screws *4
- Fixing bracket between batteries installed in the battery: M5 screws *2

NOTICE

The battery system needs to be mounted on a base or hanger. Please select the base or the hanger according to the installation conditions. The specific delivery content is subject to the actual selection.

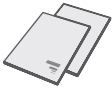
(Optional) base

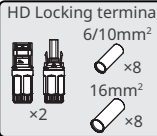
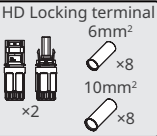
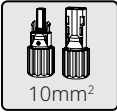
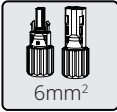
				
Base x 1	M5 screws x 2	Fixing bracket between base and battery x 2	PE terminal x 1	Terminal resistor x 1
				
Power connection terminal tightening tool x 1	Power connection terminal tightening tool x 1	Power connection terminal tightening tool x 2		
				
		HD Locking terminal 6/10mm ² 6/10mm ² ×8 16mm ² ×8 ×2		HD Locking terminal 6mm ² 6mm ² ×8 10mm ² ×8 ×8
Power connection terminal x 2	Power connection terminal x 2	Power connection terminal		hexwrench x1

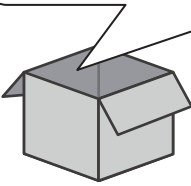

[2]:
 The quantity of adjustable feet is subject to actual shipment. If there are no adjustable feet in the actual delivery and you need use them, please contact the dealer or after-sales service to obtain them.

(Optional) wall mount rack

Wall mount rack x 1

Front protective cover x 1

Protective cover x 2

Fixing bracket between rack and battery x 2

M5 screws x 2

M12 expansion bolts x 4

M4 screws x 5

PE terminal x 1

Terminal resistor x 1

Power connection terminal tightening tool x 1

Power connection terminal tightening tool x 1

Power connection terminal tightening tool x 2

Document x 1

Power connection terminal x 2 (10mm²)

Power connection terminal x 2 (6mm²)

Power connection terminal (HD Locking terminal 6/10mm² x2, 16mm² x8, 10mm² x8)

hexwrench x1

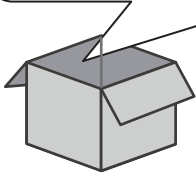

4.3 Storage

If the equipment is not to be installed or used immediately, please ensure that the storage environment meets the following requirements:

1. Do not unpack the outer package or throw the desiccant away.
2. Complete the equipment installation in three days after unpacking it. Pack and store the equipment using the original packing box if it is not installed.
3. The height and direction of the stacking equipment should follow the instructions on the packing box.
4. The equipment must be stacked with caution to prevent them from falling.
5. Keep the equipment away from flammable, explosive, and corrosive matters.
6. Place the equipment in a cool place where away from direct sunlight.
7. Store the equipment in a clean place. Make sure the temperature and humidity are appropriate and no condensation.
8. Recommended storage humidity: 0%~95%RH (no condensation). Do not install the battery system if there is any moisture or condensation.
9. In order to protect the performance and life of the battery, it is recommended to avoid unused storage for a long period of time. Prolonged storage may cause deep discharging of the battery, resulting in irreversible chemical loss, leading to capacity degradation or even complete failure, timely use is recommended. If the battery is to be stored for a long period of time, please maintain it as follows:

Specific Model	Battery storage initial SOC range	Recommended Storage Temperature	Charing and Discharging Maintaining Period[1]	Battery Maintaining Method[2]
LX D5.0-10	30%~40%	0~35°C	-20~35°C, ≤12 months 35~+45°C, ≤6 months	Contact the dealer or the after-sales service for maintenance methods.

NOTICE

[1] The storage time starts from the SN date on the outer packaging of the battery and requires charging and discharging maintenance after the storage cycle is exceeded. (Battery maintenance time = SN date + charging/discharging maintenance cycle). To view the SN date, please refer to the meaning of SN code.

[2] After passing the charging/discharging maintenance, if there is a Maintaining Label attached to the outer box, then please update the maintenance information on the Maintaining Label. if there is no Maintaining Label, please record the maintenance time and SOC of the batteries and keep the data to facilitate the keeping of maintenance records.

5 Installation

5.1 Installation Requirements

Installation Environment Requirements

NOTICE

- The main source of battery operation sound comes from the active cooling system, specifically the axial flow cooling fan with hydrodynamically optimized design.
- When the battery produces $\leq 35\text{dB (A)}$ regular airflow sound, it characterizes the cooling system is in normal working condition and will not have any impact on the electrical performance, structural safety and life of the equipment. If you are sensitive to the noise, please choose the installation location reasonably.

1. Do not install the equipment in a place near flammable, explosive, or corrosive materials.
2. Do not install the equipment in a place that is easy to touch, especially within children's reach. High temperature exists when the equipment is working. Do not touch the surface to avoid burning.
3. Avoid the water pipes and cables buried in the wall when drilling holes.
4. Install the equipment in a sheltered place to avoid direct sunlight, rain, and snow. Build a sunshade if it is needed.
5. The place to install the equipment shall be well-ventilated for heat dissipation and large enough for operations.
6. The equipment with a high ingress protection rating can be installed indoors or outdoors. The temperature and humidity at the installation site should be within the appropriate range.
7. Install the equipment at a height that is convenient for operation and maintenance, ensuring that the equipment indicator lights, all labels are easy to view, and the wiring terminals are easy to operate.
8. The altitude to install the equipment shall be lower than the maximum working altitude 4000m.
9. Install the equipment away from electromagnetic interference. If there is any radio or wireless communication equipment below 30MHz near the equipment, make sure that the inverter is at least 30m far away from the wireless equipment.

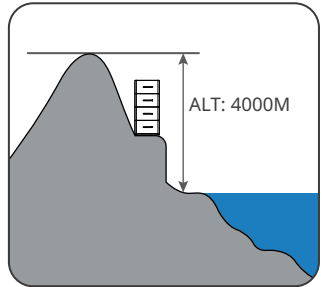
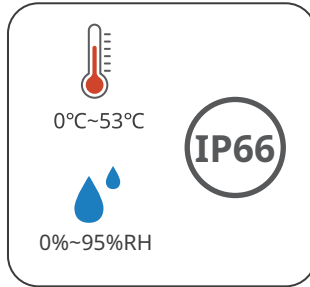
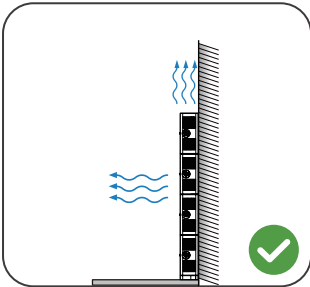
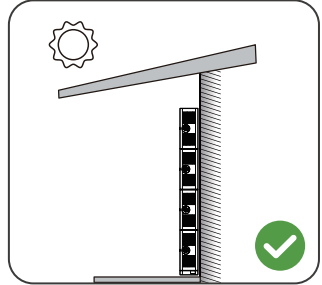
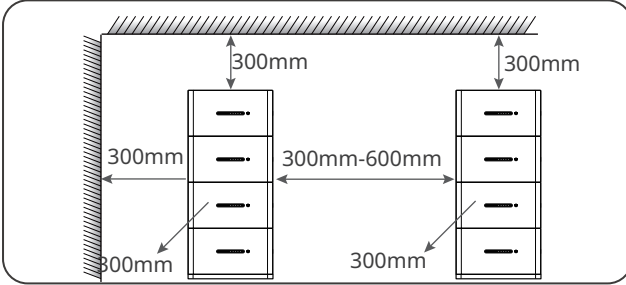
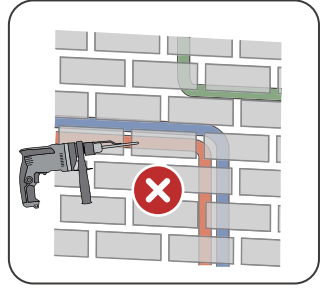

NOTICE

If installed in an environment below 0°C, the battery will not be able to continue charging to restore energy after being discharged, resulting in undervoltage protection.

Lynx home D : Charging temperature range: 0<T<53°C ; Discharging temperature range : -20<T<53°C.

Mounting Support Requirements

- The mounting support shall be nonflammable and fireproof.
- Install the equipment on a surface that is solid enough to bear its weight.
- Put the battery system near the wall and install the locking brackets to prevent the battery from falling down.

Installation Angle Requirements

Install the equipment vertically, no tilt or upside down.

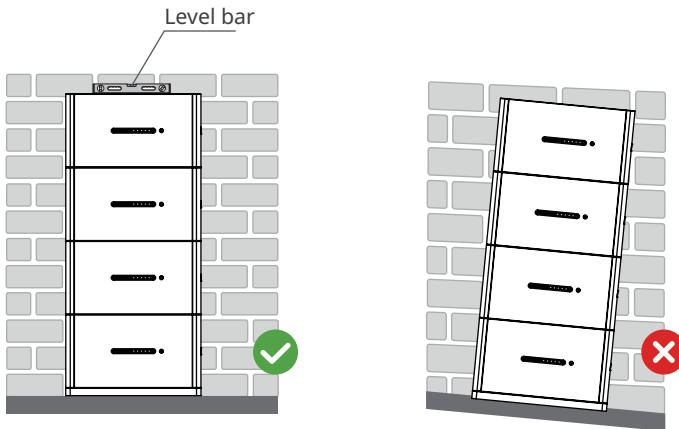

5.2 Moving the Equipment

- Operations such as transportation, shipment, installation and so on shall in compliance with the laws and regulations of the country or region where the inverter is located.
- Move the equipment to the site before installation. Follow the instructions below to avoid personal injury or equipment damage.
 1. Consider the weight of the equipment before moving it. Assign enough personnel to move the equipment to avoid personal injury.
 2. Wear safety gloves to avoid personal injury.
 3. Keep balance to avoid falling down when moving the equipment.

5.3 Installing the Battery System

NOTICE

- The battery system has to be installed on a base or on a wall mount rack.
- When stacking batteries, auxiliary tools need to be used for installation.
- When a single group of battery exceeds 3 pieces, it is recommended to use a base installation.
- Please stack the batteries based on the recommended stacking method.

Battery Stacking Method		
Total Quantity of Batteries (blocks)	First stack (block)	second stack (block)
8	4	4
7	4	3
6	3	3
5	3	2
4	2	2
3	3	-
2	2	-
1	1	-

5.3.1 Installing the Wall Mount Rack (Optional)

Step 1: Make the wall mount rack tightly adhere to the wall. Ensure that the rack is securely placed and use a level bar to measure if the rack is level.

Step 2: After adjusting the position and levelness of the rack, mark the drilling positions, then remove the rack.

Step 3: Drill holes and install expansion bolt.

1. Step 4: Use an impact drill to drill hole (hole diameter: 15mm, depth: 60mm).
2. Clean the hole.
3. Use a rubber hammer to install the expansion screw into the hole.
4. Use an external hex wrench to tighten the nut clockwise to expand the screw.
5. Rotate the nut counterclockwise to remove it.

Step 4: Use external hex wrench to install the rack on the wall.

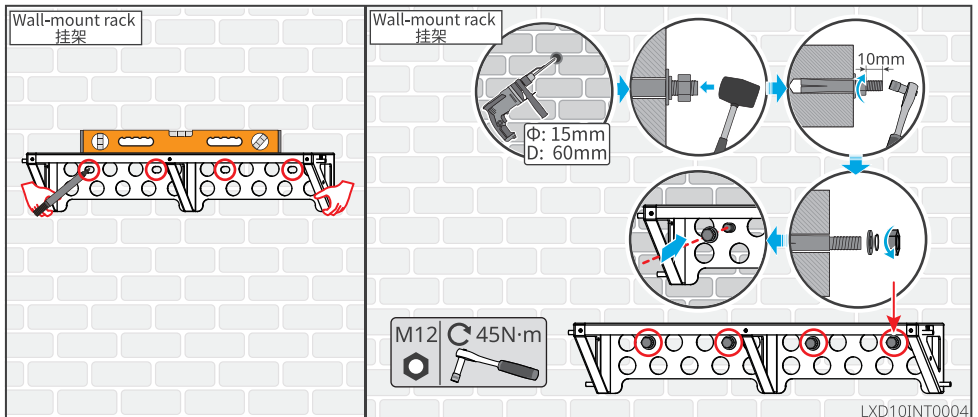

5.3.2 Installing the Base (Optional)

NOTICE

Check whether there are adjustable feet in the package. If not and you need them, please contact the dealer or after-sales service to obtain them.

Install the adjustable feet to the base.

Place the base 15-20mm away from the wall, parallel to the wall, and ensure that the ground is level.

When installing the battery using the base, ensure that the left side of the battery is tightly against the limit block on the base.

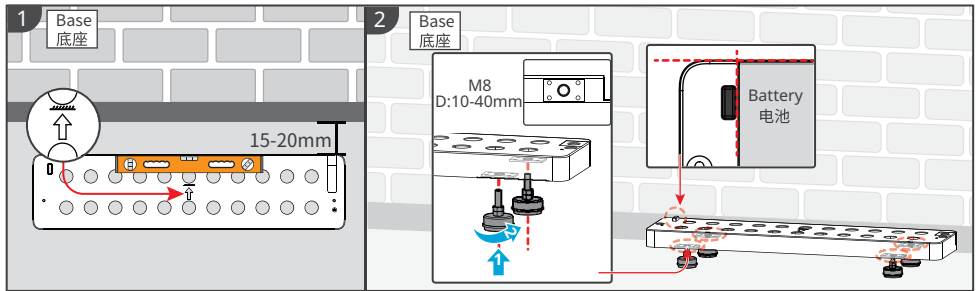

5.3.3 Installing the Battery System

Step 1: Fix the locking bracket onto the battery.

Step 2: Mark the drilling position, and drill holes.

1. Use an impact drill to drill holes (hole diameter: 8mm, depth: 60mm).
2. Clean the hole.

Step 3: Install expansion bolt.

1. Use a rubber hammer to install the expansion screw into the hole.
2. Use an external hex wrench to tighten the nut clockwise to expand the screw.
3. Rotate the nut counterclockwise to remove it.

Step 4: Reinstall the battery on the base or rack, and adjust the battery position to make it 15-20mm away from the wall.

Step 5: Use an external hex wrench to secure the battery to the wall, and use a torque screwdriver to secure the locking bracket to the battery.

Step 6: If multiple batteries need to be installed, please repeat steps 3 to 4 to complete all battery installations.

Step 7: Use locking brackets to secure the battery to the base or rack and then secure the batteries in sequence.

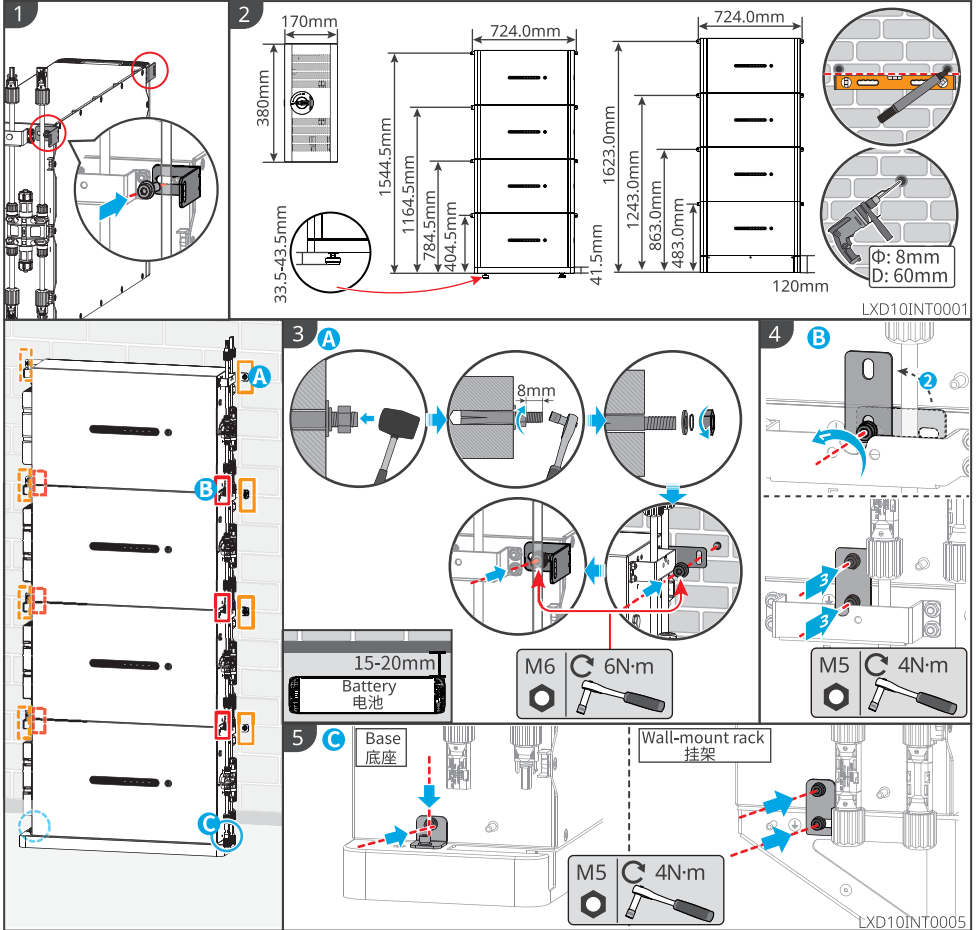

6 Electrical Connection

6.1 Safety Precaution



- High voltage exists during the battery system running. Power off the battery system before any operations to avoid danger. Strictly follow all safety precautions outlined in this manual and safety labels on the equipment during the operation.
- Perform electrical connections in compliance with local laws and regulations. Including operations, cables, and component specifications.
- Tie the cables of the same type together, and place cables of different types apart. Do not place the cables entangled or crossed.
- Make sure that the cable conductor is in full contact with the wiring terminal and the cable insulation part is not crimped with the wiring terminal when crimping the terminal. Otherwise, the equipment may not be able to work properly or heating due to unreliable connection after operation, resulting in damage to the battery terminal.

NOTICE

- Wear personal protective equipment like safety shoes, safety gloves, and insulating gloves during electrical connections.
- All electrical connections should be performed by qualified professionals.
- The cable colors in this document are for reference only, and the specific cable specifications must comply with local regulations.
- For Australian market, an overcurrent protection and isolation device that operates both positive and negative conductors simultaneously are required between inverter and battery system and between parallel battery systems.

6.2 Electrical Connection

NOTICE

- A single group of battery system can stack up to 4 batteries.
- The battery system supports up to two groups of 8 batteries for capacity expansion.
- The communication port functions of the battery are consistent. Please ensure that one communication port of Battery 1 is connected to the inverter, and the other communication port is connected other battery. Please ensure that the communication port of battery n+m has a terminal resistor installed. If the terminal resistor is not installed, it will cause the battery system to not function properly.
- Please seal the unused power port on battery.

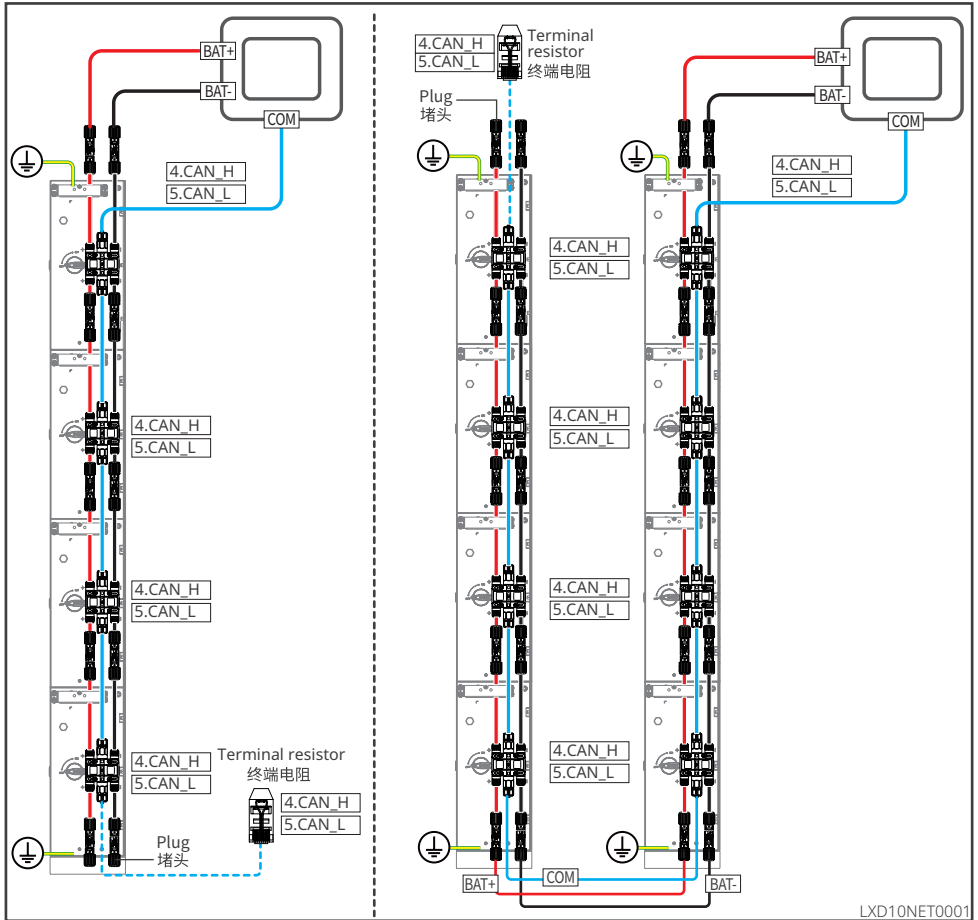
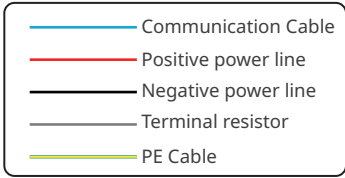

6.3 Connecting the PE Cable

NOTICE

- Connect the PE cable first before installing the equipment. Disconnect the PE cable before dismantling the equipment.
- Make sure that the drawing force of the cable after crimping is greater than 400N.
- The PE cable should be prepared by the customer. Recommended specifications:
 - Type: single-core outdoor copper cable
 - Conductor cross-sectional area: 6mm^2

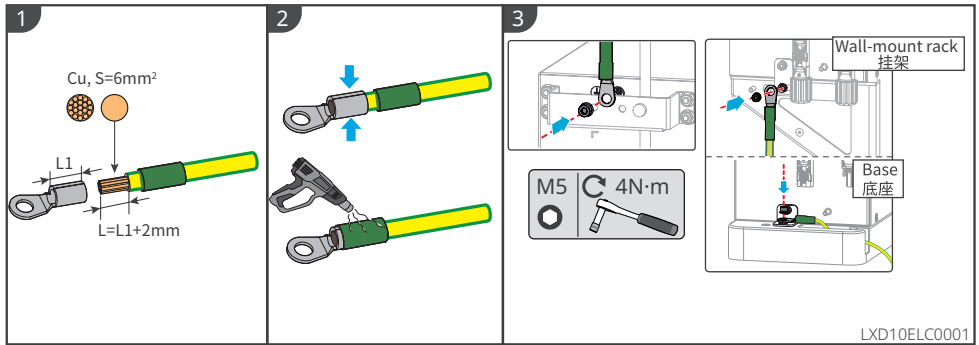

6.4 Connecting the DC power cable



- The DC power cable should be prepared by the customer. Recommended specifications:
 - Type: single-core outdoor copper cable
 - Please choose the appropriate crimp terminals for the cables based on the actual connected devices.
- Please use appropriate hydraulic pliers according to the DC connector model. The recommended specifications are:
 - The recommended tool for crimping battery DC terminals without HD Locking terminal labels on the ziplock bag in the delivery is the YQK-70 hydraulic pliers.
 - The recommended tool for crimping battery DC terminals with HD Locking terminal labels on the ziplock bag in the delivery is the VXC9 hydraulic pliers.
 - If the recommended hydraulic plier cannot be purchased, please choose the crimping tool according to the terminal size to ensure that the crimped terminals meet the usage requirements.
- Make sure that the drawing force of the cable after crimping is greater than 310N.
- If the DC port does not require a cable connection, please install a waterproof plug, otherwise it may affect the equipment's protection level.
- Please use the DC connectors and terminals delivered to connect the power cables:
 - For the black power cable of the battery system with a HD word label or with a white number tube, please plug it into the connector with the HD Locking terminal label on the ziplock bag in the delivery.
 - For the black power cable of the battery system without a HD word label or without a white number tube, please check whether the HD Locking terminal label is affixed to the ziplock bag containing the power connectors. If no, the male and female connectors should be plugged into each other. If there is an HD Locking terminal label, please contact the dealer or after-sales service.

Connecting power cables between two groups of batteries

1 Type I

7mm
Φ: 5-8.5mm
Cu, 10mm²

2

YQK-70

1 Type II

HD Locking terminal

15mm
Φ: 6.0-9.5mm
Cu, 10mm²

2

VXC9

M5 C 1.5-2N·m

3

4

LXD10ELC0002

Connecting power cables between battery and inverter

1 Type I

7mm
Φ: 5-8.5mm
Cu, 10mm² or 6mm²

2

YQK-70

3 10mm² / 6mm²

4

BAT+ | BAT-

1 Type II

HD Locking terminal
15mm
Φ: 6.0-9.5mm
Cu, 10mm² or 6mm²

2

VXC9

M5 C 1.5-2N·m

3

4

BAT+ | BAT-

HD***-*****-***

LXD10ELC003

Disassemble the HD Locking terminal connector

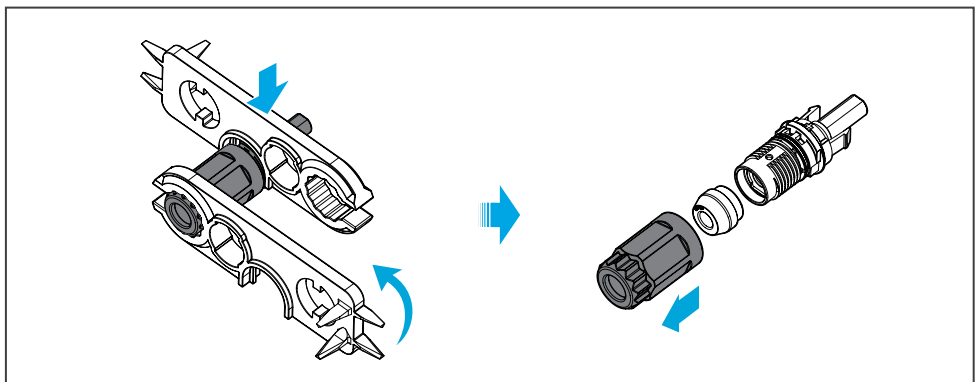

If you need to remove the power connector, please refer to the following steps and use the tools delivered with the box.

Type I

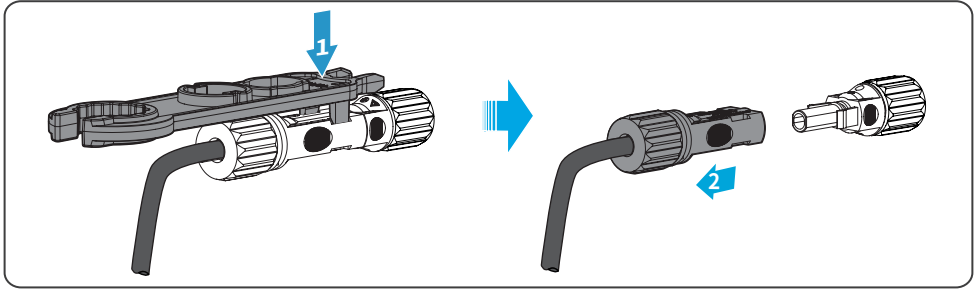

Type II

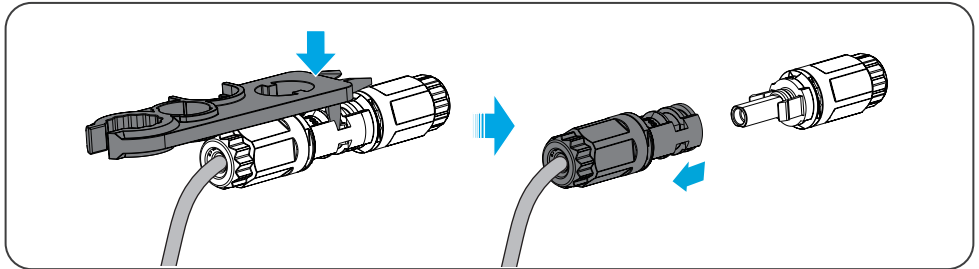

6.5 Connecting the Communication Cable and Installing the Terminal Resistor

WARNING

- The communication cables between inverter and battery, and cables between batteries, need to be prepared by the customers. Recommended specifications: standard direct network cable and RJ45 connector.
- Please use the communication cable shipped with the box for communication connections between batteries in the same group.
- Some inverters have been shipped with communication cables for connecting inverter and battery, which can be used according to actual needs.
- If the terminal resistor is not installed, it may cause the battery system not to work properly.
- Do not remove the waterproof plug during installation.

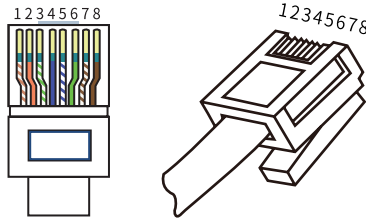

Port Definition

PIN	Color	Definition	Description
1	Orange and White	RS485A	Reserved
2	Orange	RS485B	
4	Blue	CAN_H	Communication between battery and inverter or between batteries
5	Blue and White	CAN_L	
3,6,7,8	Green and White, Green, Brown and White, Brown	-	

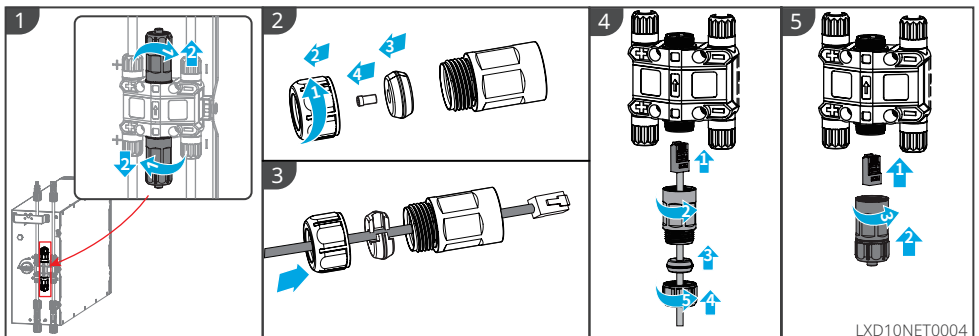

6.6 Installing Protective Cover

NOTICE

Before installing the front protective cover of the rack, please remove the release paper on the back of the protective cover.

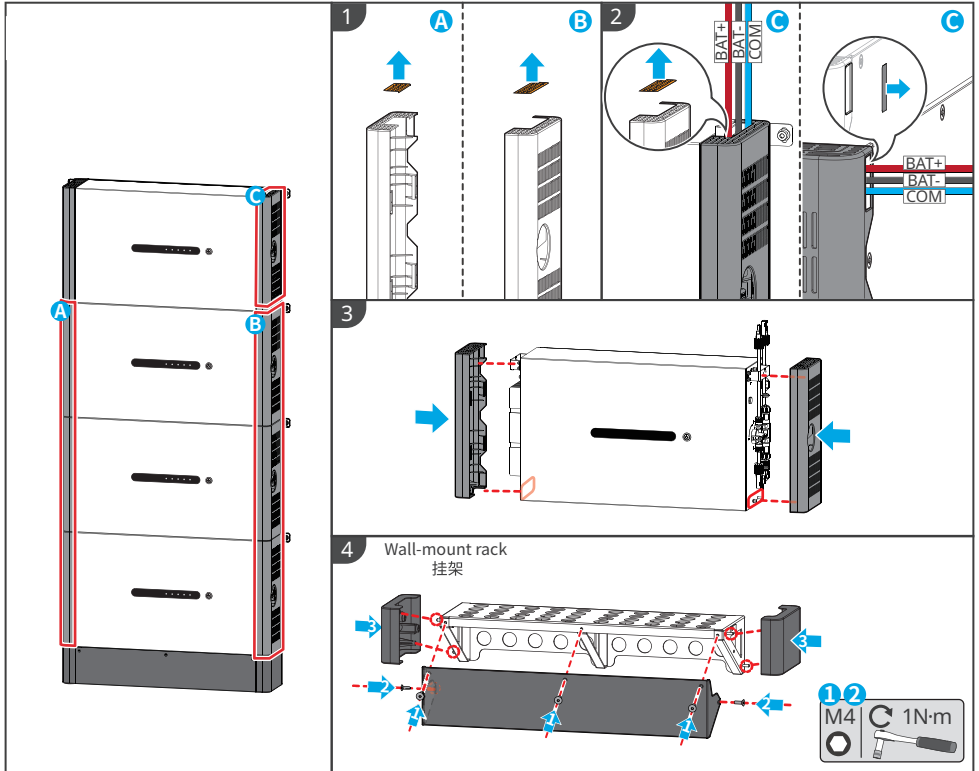

7 System Operation

7.1 Check Before Power On

Check the following items before power on to avoid the battery system being damaged.

No.	Check Item
1	The product is firmly installed at a clean place that is well-ventilated and easy-to-operate.
2	The PE cable, power cables, communication cables and terminal resistors are connected correctly and securely.
3	Cable ties are intact, routed properly and evenly.
4	Unused ports and terminals are sealed.

7.2 Battery System Power On



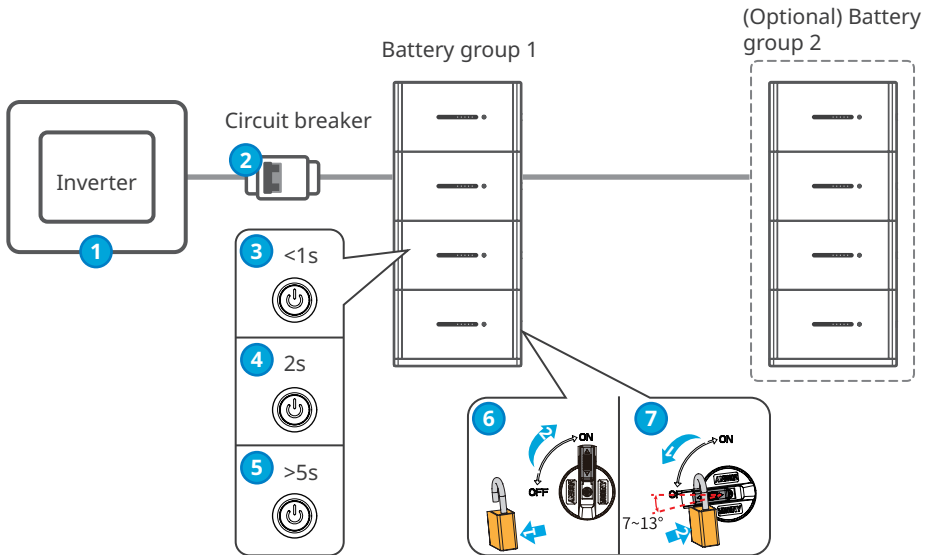

NOTICE

Install the circuit breaker between the inverter and the battery in compliance with local laws and regulations.



DC switch lock is only used in Australia





Power ONTurn on: 

-  Turn on the breaker between the inverter and the battery system.
-   Turn the battery power switch to the ON position and short press the battery multi-functional button. All batteries need to be powered on separately.
-  Power on the inverter in the energy storage system. Please refer to the corresponding inverter user manual for detailed operations.

Black Start

Black start: In energy storage system, it is only used when there is no power on the PV side and grid side, and the inverter's off-grid function needs to be activated.

Turn on: 

-  Turn on the breaker between the inverter and the battery system.
-   Turn the battery power switch to the ON position and short press the battery multi-functional button. All batteries need to be powered on separately.
-  Wait for 15 seconds after all batteries are powered on, and press the multi-functional button on any battery for 2 seconds.

7.3 Setting Battery Parameters

NOTICE

To ensure the normal operation of the battery system, after the battery system is powered on, the user needs to select correct battery model through the SolarGo App.

Step 1: Download the SolarGo App.

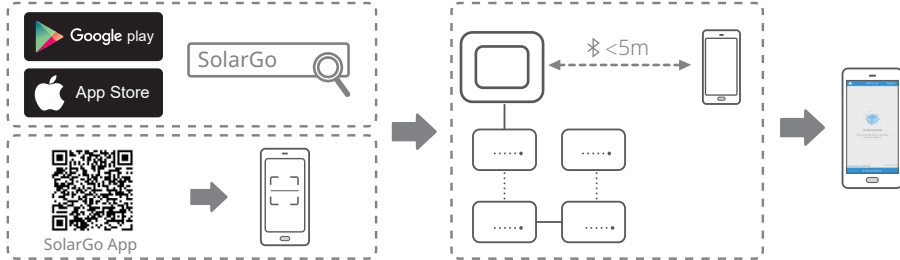

Step 2: Connect inverter.

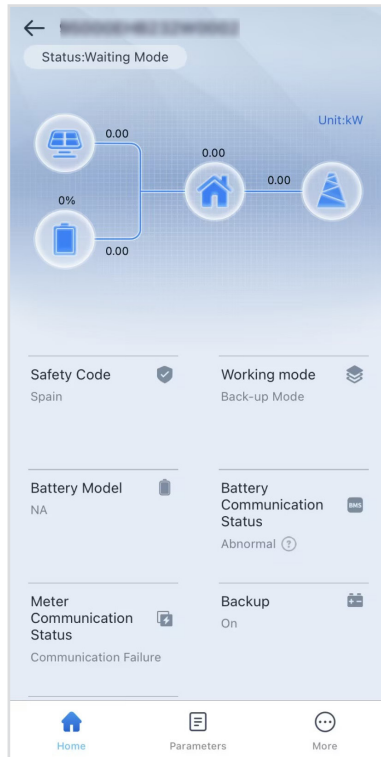
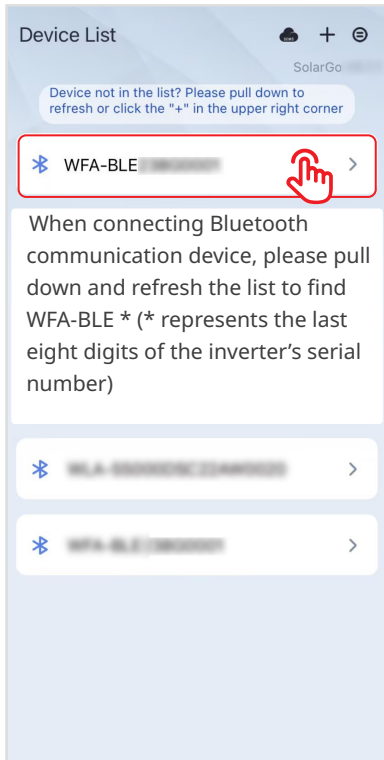

Step 3: Go to homepage, then click More>Quick Setting>BAT Access Mode>Battery Access to enter the parameter setting page. Follow the prompts on the interface to enter the battery model selection interface and set the battery model.

NOTICE

- Incorrect battery model may cause system failure. Please set the battery model correctly.
- If only one battery is used, please select "Lynx Home D Series"; If multiple batteries are used, please select "Lynx Home D Series * N".

Select Battery Model

Selected Battery
Manufacturer:--
Series:--
Model:--

GoodWe

LX F-H-JP	✓
LX F-H-US	✓
LX S-H	✓
Lynx Home D Series	✓
Lynx Home D Series*N	✓
Lynx Home F Series G2	✓
Lynx Home F Series G2*N	✓

Select the brand and model of the battery that is actually connected to the inverter.



If there is no available battery model, please open the mobile network and restart the app to obtain one.

Next

Lynx Home D Series or Lynx Home D Series *N

7.4 Indicator Status

Normal status

<p>SOC indicator status</p> 	<p>Button indicator status</p> 	<p>Battery system status</p>
<p>SOC indicator indicates SOC of the battery system.</p> <p>○ ○ ○ ○ ○ SOC<5%</p> <p>● ○ ○ ○ ○ 5%≤SOC<25%</p> <p>● ● ○ ○ ○ 25%≤SOC<50%</p> <p>● ● ● ○ ○ 50%≤SOC<75%</p> <p>● ● ● ● ○ 75%≤SOC<95%</p> <p>● ● ● ● ● 95%≤SOC≤100%</p>	<p>Green light blinks</p>	<p>The battery system is in standby status.</p>
<p>The last SOC indicator blinks 1 time/s.</p> <ul style="list-style-type: none"> • When 5%≤SOC<25%, SOC 1 blinks. • When 25%≤SOC<50%, SOC 2 blinks. • When 50%≤SOC<75%, SOC 3 blinks. • When 75%≤SOC<95%, SOC 4 blinks. • When 95%≤SOC≤ 100%, SOC 5 blinks. 	<p>Steady green light</p>	<p>The battery system is in charging status.</p> <p>Note: When the battery SOC reaches the charging limit, the charging will stop.</p>
<p>The last SOC indicator blinks 1 time/s.</p> <ul style="list-style-type: none"> • When 5%≤SOC<25%, SOC 1 blinks. • When 25%≤SOC<50%, SOC 2 blinks. • When 50%≤SOC<75%, SOC 3 blinks. • When 75%≤SOC<95%, SOC 4 blinks. • When 95%≤SOC≤ 100%, SOC 5 blinks. 	<p>Steady green light</p>	<p>The battery system is in discharging status.</p> <p>Note: When there is no need to supply power to the load in the system or the battery SOC is below the set discharge depth, the battery will no longer discharge.</p>

Abnormal status

<p>Button indicator status</p> 	<p>Battery system status</p>	<p>Solutions</p>
<p>Red light blinks</p>	<p>Battery system alarm</p>	<p>After an alarm occurs in the battery system, the alarm information can be viewed through the SolarGo App.</p>
<p>Steady red light</p>	<p>Battery system fault</p>	<p>Check the SOC indicator status or SolarGo App to determine the fault that has occurred and handle the problem follow the methods recommended in the Troubleshooting section.</p>

8 Maintenance

8.1 Battery System Power Off



- Power off the battery system before operations and maintenance. Otherwise, the equipment may be damaged or electric shocks may occur.
- Strictly follow the power off requirements to avoid damaging the system.

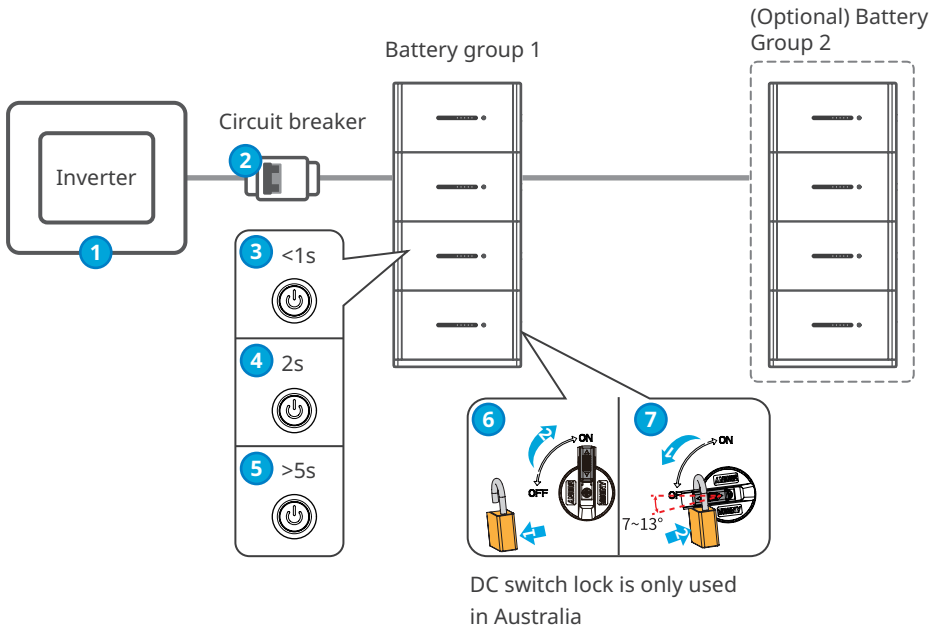

Power OFF



- 1 Power off the inverter in the energy storage system. Please refer to the corresponding inverter user manual for detailed operations.
- 5 Press the multi-functional button on any battery for 5 seconds to power off the battery, and wait for 15s.
- 7 All battery power switches need to be turned to the OFF position.
- 2 Turn off the breaker between the inverter and the battery system.

8.2 Routine Maintenance

WARNING

- Contact the after-sales service for help if you find any problems that may influence the battery or the hybrid inverter. Disassemble without permission is strictly forbidden.
- Contact after-sale service for help if the copper conductor is exposed. Do not touch or disassemble privately because the high voltage danger exists.
- In case of other emergencies, contact the after-sales service as soon as possible. Operate following the instructions or wait for the after-sales service personnel.
- If you need to replace the battery or expand the capacity, please contact the dealer or after-sales personnel.

Maintaining Item	Maintaining Period
Check whether the locking bracket is secured, tighten it if not.	Once every 6 months
Check whether the outer enclosure is broken. Repair the painting or contact the after-sales service if there is any broken.	Once every 6 months
Check whether the cables are exposed. Replace the exposed cable or contact the after-sales service for help.	Once every 6 months
Check whether there is any dust around the battery module. Clean the dust if there is any to avoid affecting heat dissipation.	Once every 6 months
Check whether there is any liquid or pest near the battery to avoid intrusion in a long term.	Once every 6 months













8.3 Troubleshooting



















Fault	Cause	Solutions
Battery system tilt	The ground is uneven or deformed.	Place the battery on a flat and hard ground.
Indicator light goes out during operation	Cable short circuit or internal failure of battery system.	<ol style="list-style-type: none"> 1. Check for short circuits in external cables. 2. Turn off the battery system and wait for 2 hours, then turn it on.
Button indicator light turns to red and flashes, and the SOC light displays battery level	<ol style="list-style-type: none"> 1. Communication cable fault. 2. The battery model set in SolarGo App is incorrect. 	<ol style="list-style-type: none"> 1. Check if the communication cables are correct. 2. Check if the inverter is working properly. 3. Set correct battery system model through the SolarGo App.













8.4 System Troubleshooting

The battery system may power off automatically and some functions may not work properly once the battery system fails. Perform troubleshooting according to the following methods. Contact the after-sales service if these methods do not work. Collect the information below before contacting the after-sales service, so that the problems can be solved quickly.

1. Battery information, such as: serial number, software version, when the device was installed, when the fault occurred, how often it occurred, etc.
2. Ambient environment, such as: weather conditions and installation environment. Photos, videos and other files can be provided to assist in the analysis of the problem.
3. When an alarm or fault occurs, only the multi functional button indicator light of the main battery flashes or stays on.
4. In a system with multiple batteries, the battery with the smallest SN number is the main battery by default. The installation sequence of the battery does not affect the master-slave relationship.

Multi-function button indicator	SOC indicator status	Fault	Solutions
 Red light steady ON		Battery Overvoltage	Power off and wait for 2 hours. Contact the after-sale service if the problem persists.
 Red light steady ON		Battery Undervoltage	Contact the after-sales service.
 Red light steady ON		High Cell Temperature	Power off and wait for 2 hours. Contact the after-sale service if the problem persists.
 Red light steady ON		Low Charging Temperature	Power off and wait for the temperature to recover. Contact the after-sale service if the problem persists.
 Red light steady ON		Low Discharging Temperature	Power off and wait for the temperature to recover. Contact the after-sale service if the problem persists.
 Red light steady ON		Overcurrent Charging	Restart the battery. Contact the after-sale service if the problem persists.

 Red light steady ON		Overcurrent Discharging	Restart the battery. Contact the after-sale service if the problem persists.
 Red light steady ON		Temperature Difference Exception	Power off and wait for 2 hours. Contact the after-sale service if the problem persists.
 Red light steady ON		Voltage Difference Exception	Restart the battery and wait for 12 hours. Contact the after-sale service if the problem persists.
 Red light steady ON		Wire Harness Exception	Restart the battery. Contact the after-sale service if the problem persists.
 Red light steady ON		MOS cannot be closed	Restart the battery. Contact the after-sale service if the problem persists.
 Red light steady ON		MOS adhesion	Restart the battery. Contact the after-sale service if the problem persists.
 Red light steady ON		Parallel connection fault	Check the battery model. Contact the after-sale service if the battery model is incorrect.
 Red light steady ON		BMU Communication Fault	Restart the battery. Contact the after-sale service if the problem persists.
 Red light steady ON		MCU Internal Communication Fault	Restart the battery. Contact the after-sale service if the problem persists.

 Red light steady ON		Precharge Failure	Restart the battery. Contact the after-sale service if the problem persists.
 Red light steady ON		MOS over temperature fault	Power off and wait for 2 hours. Contact the after-sale service if the problem persists.
 Red light steady ON		Current diverter over temperature fault	Power off and wait for 2 hours. Contact the after-sale service if the problem persists.
 Red light steady ON		BMS Hardware overcurrent fault	Power off and wait for 2 hours. Contact the after-sale service if the problem persists.
 Red light steady ON		DCDC fault	Power off and wait for 2 hours. Contact the after-sale service if the problem persists.
 Red light steady ON		Microelectronic fault	Contact the after-sales service.
 Blinks	-	Inverter communication loss	Please check if the inverter communication cable is normal. If the problem persists after reconnecting, please contact the after-sales service.

9 Technical Parameters

Technical Data		LX D5.0-10
Usable Energy (kWh) *1		5
Cell Type		LFP (LiFePO ₄)
Cell Configuration		16S1P
Nominal Voltage (V)		Charge:435;Discharg:380
Output Voltage (V)		320~480
Nominal Power (kW) *2		3
Peak Power (kW) *2		5KW,10s
Operating Temperature Range (°C)		Charge: 0~+53;Discharge: -20~+53
Relative Humidity		0~95%
Max. Operating Altitude (m)		4000
Communication		CAN
Weight (kg)		52
Dimensions (W×H×D mm)		700×380×170
Ingress Protection Rating		IP66
Storage Temperature (°C)		0~+35(< One Year);-20~0(≤One Month)
Mounting Method		Floor stacked/ Wall-mounted
Standard and Certification	Safety	IEC62619, IEC60730, VDE2510-50, CE , CEC
	EMC	CE, RCM
	Transportation	UN38.3
*1: Test conditions,100% DOD,0.2C charge & discharge at +25±3 °C for battery system at beginning life.System Usable Energy may vary with different Inverter.		
*2: Power derating will occur related to Temperature and SOC.		



GoodWe Website

GoodWe Technologies Co., Ltd.

 No. 90 Zijin Rd., New District, Suzhou, 215011, China

 www.goodwe.com

 service@goodwe.com



Local Contacts